

Simon, Andrew, James and John
left their boats to follow Jesus.

Use these pictures to draw the boat.

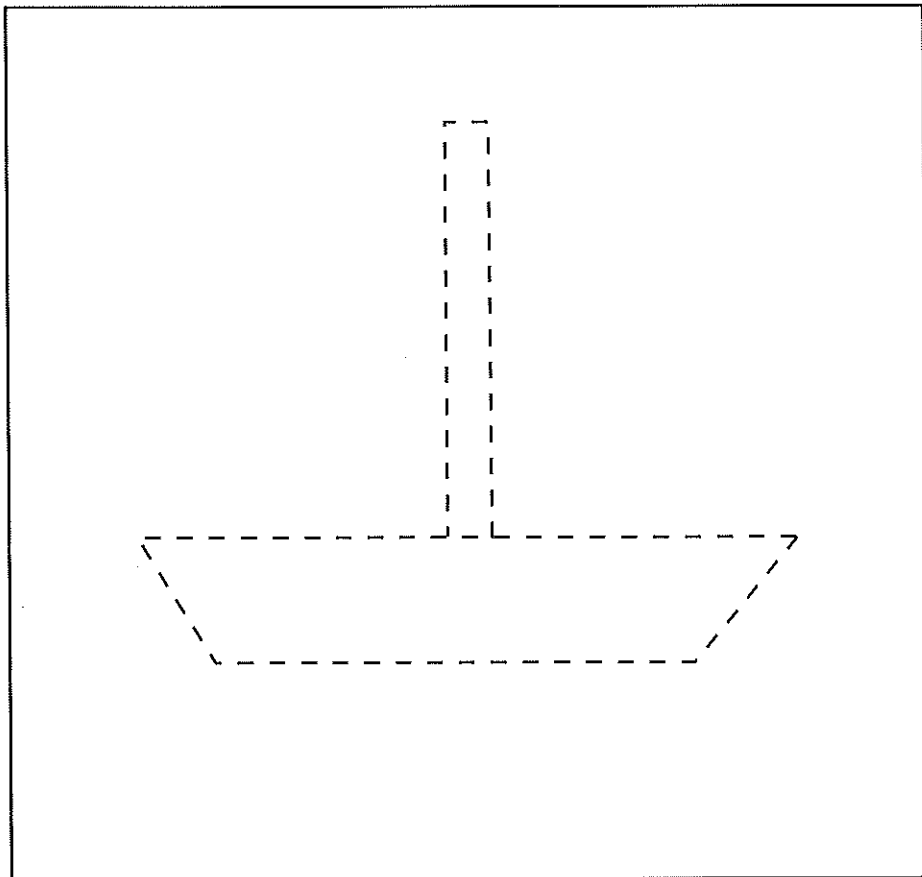
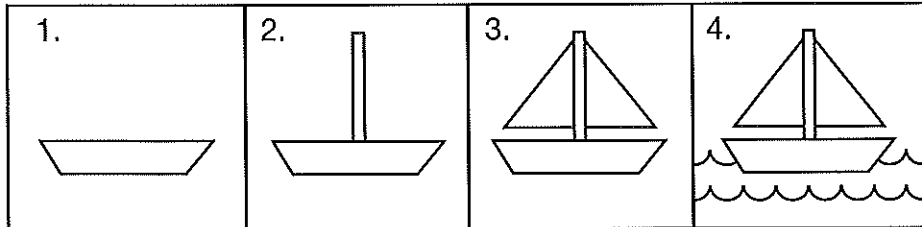

Children's Worship Bulletin

Ages 3-6

January 22, 2012 • Mark 1:14-20

Jesus Calls Simon, Andrew, James and John

Jesus preached
the good news of God!

Match the puzzle pieces.

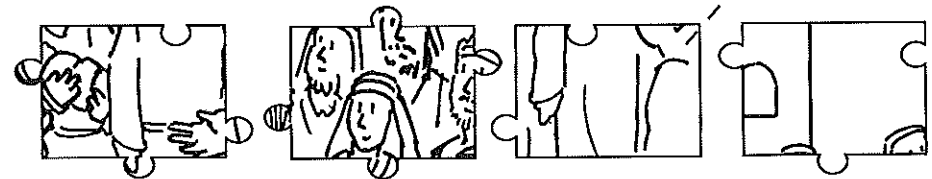
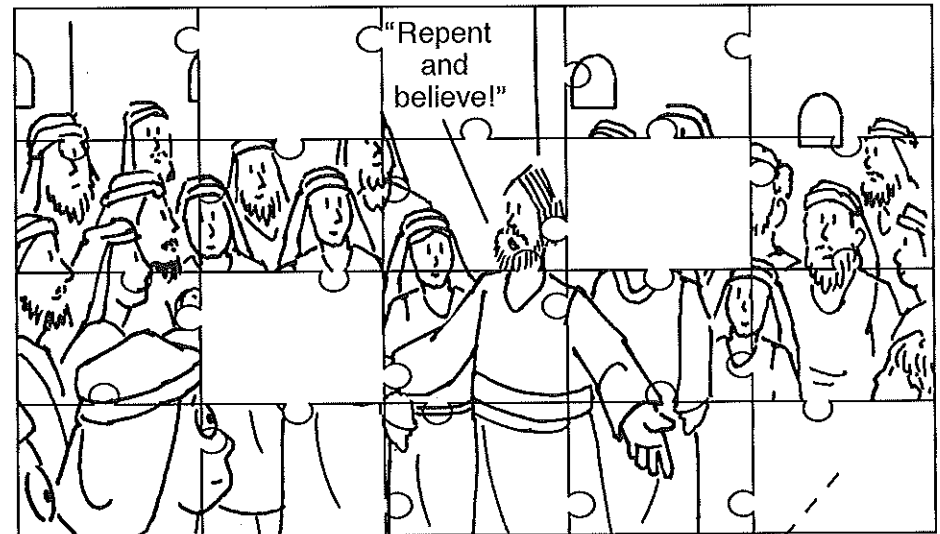

Jesus asked Simon and his brother Andrew to ...

Use the picture code.

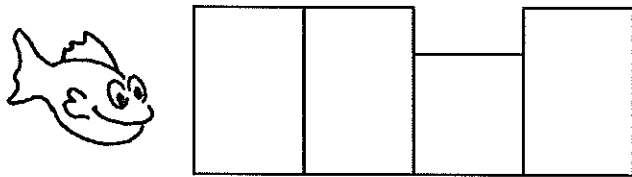
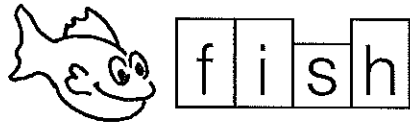
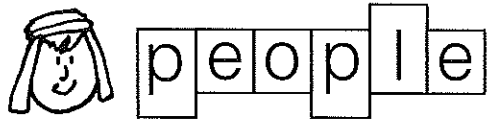

for

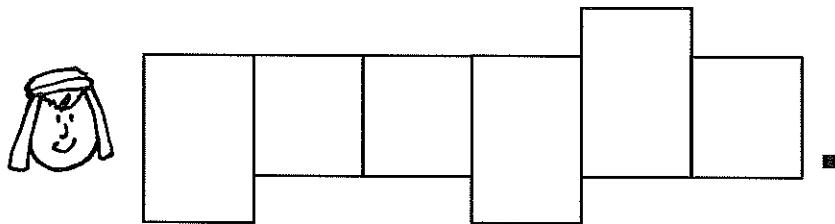

Jesus saw 2 more fishermen.
They were James and John.

Circle the 2 fishermen.

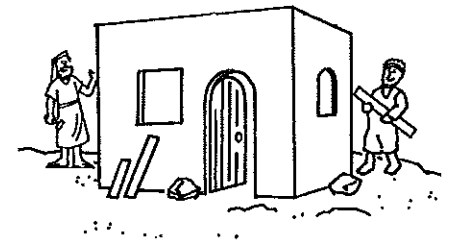



When Jesus saw James and John, He called to them. How did James and John respond?

Unscramble the letters to fill in the blanks.

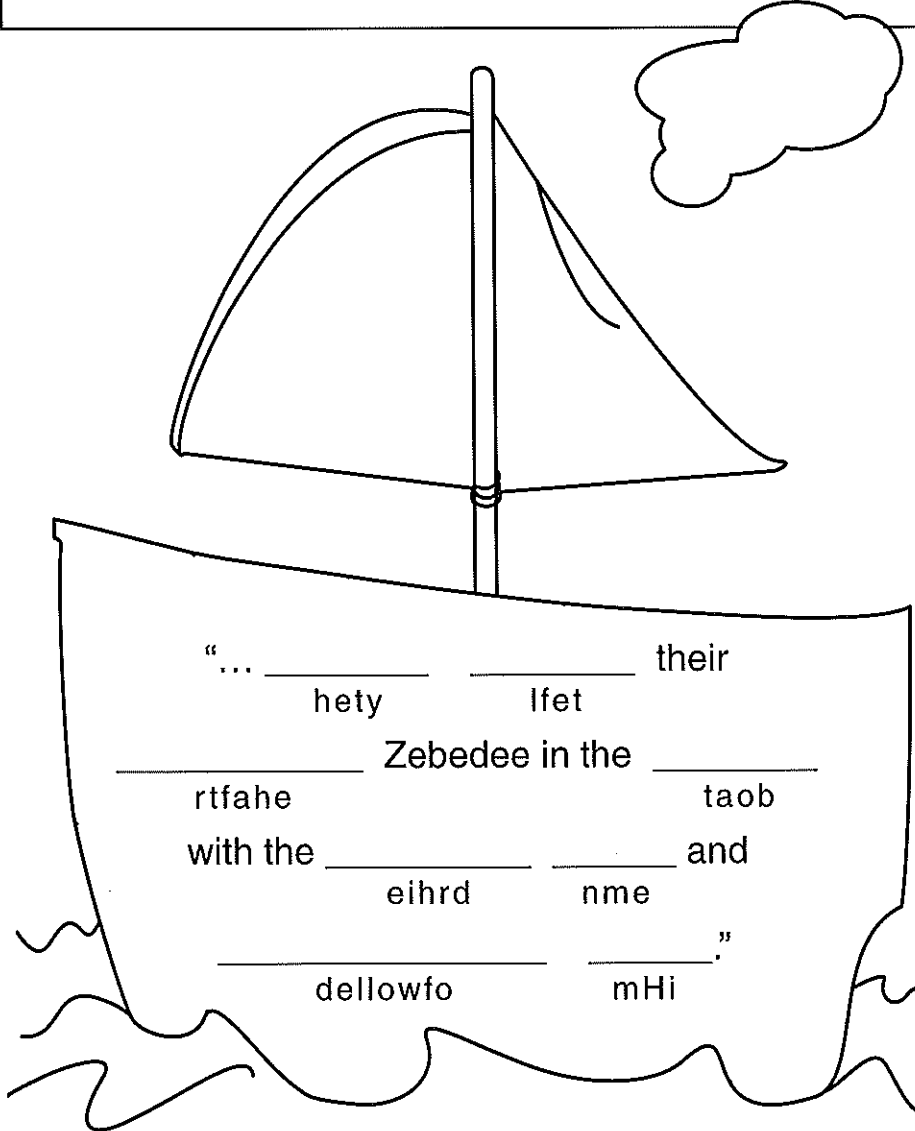

Children's Worship Bulletin™

Ages 7-12

January 22, 2012 • Mark 1:14-20

Jesus Calls Simon, Andrew, James and John

Jesus went into Galilee and preached. What did He say?



Use the clock code to fill in the blanks.

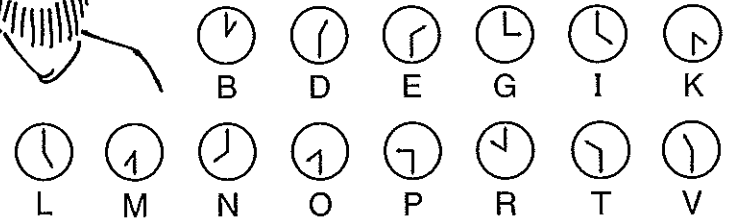

“The _____ has come,”



Jesus said. “The _____



of God is near.



and _____



the _____ news!”



Jesus saw Simon and Andrew fishing.
What did He say to them?

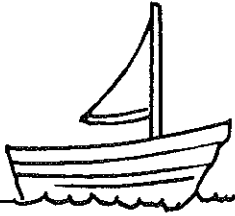

Use this code to fill in the blanks.

A	B	C	D	E	F	G	H	I	J	K	L	M	N
Z	Y	X	W	V	U	T	S	R	Q	P	O	N	M
O	P	Q	R	S	T	U	V	W	X	Y	Z		
L	K	J	I	H	G	F	E	D	C	B	A		

" _____ , _____
X L N V U L O O L D

_____ , _____
N V Q V H F H

_____ , _____
H Z R W Z M W R

D R O O H V M W B L F

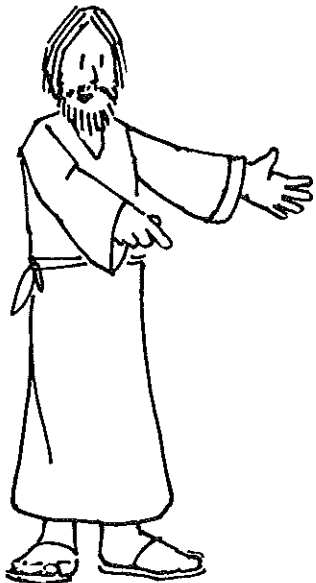

L F G G L

U R H S

U L I

K V L K O V

What did Andrew and
Simon do once Jesus called them?

Add and subtract letters to find out.

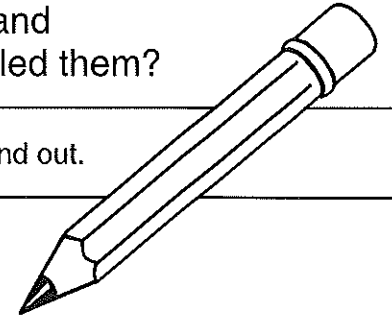

1. ARE - RE + T = _____

2. OPEN + NCE - PEN = _____

3. TABLE + FT - TAB = _____

4. NOSE + ET - OSE + S = _____

5. FISH + HOLLOW - ISHH + ED = _____

1) _____ 2) _____

they 3) _____

their 4) _____ and

5) _____

Him.

